

KÖNYÖK 45°

HOSSZÚ

d20 - d315

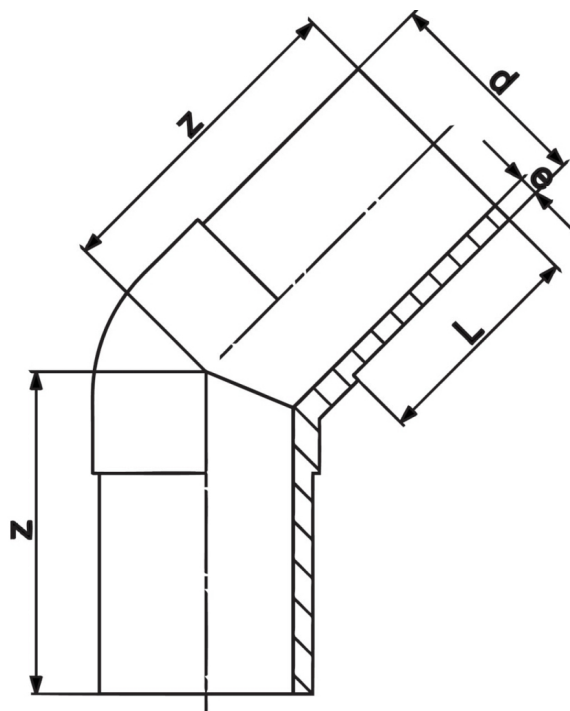

Fő tulajdonságok

Mérettartomány

d20 - d315

Anyaga

PE100 SDR11

Nyomásosztály

- Víz 16 bar
- Gáz 10 bar

d (mm)	Cikkszám	Súly (kg)	Méreték (mm)		
			z	L	e
20	076753151006000	0,027	70	52	3,0
25	076753151007000	0,037	75	52	3,0
32	076753151008000	0,050	80	54	3,0
40	076753151009000	0,086	85	57	3,7
50	076753151010000	0,133	90	63	4,6
63	076753151011000	0,227	95	65	5,8
75	076753151012000	0,350	105	72	6,8
90	076753151013000	0,565	120	81	8,2
110	076753151014000	0,921	130	86	10,0
125	076753151015000	1,290	140	92	11,4
140	076753151016000	1,796	164	120	12,7
160	076753151017000	2,454	162	102	14,6
180	076753151018000	3,274	170	107	16,4
200	076753151019000	4,362	186	116	18,2
225	076753151020000	5,981	200	123	20,5
250	076753151021000	8,283	220	130	22,7
280	076753150922000	10,285	230	140	25,4
315	076753150923000	14,124	250	150	28,6